

DIN 912 M8

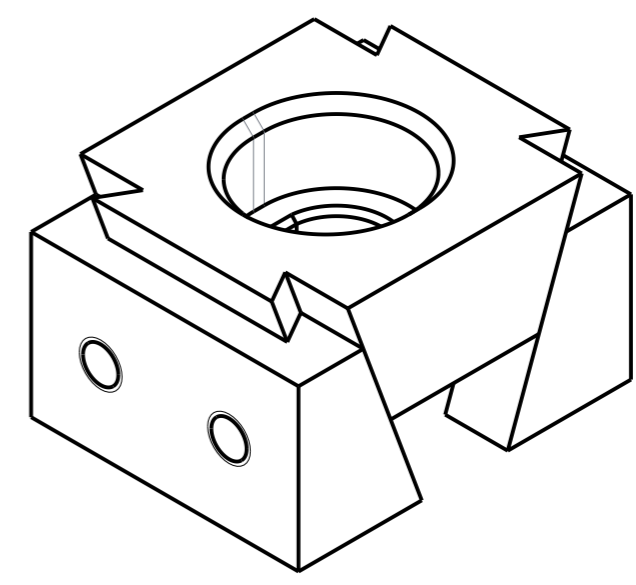
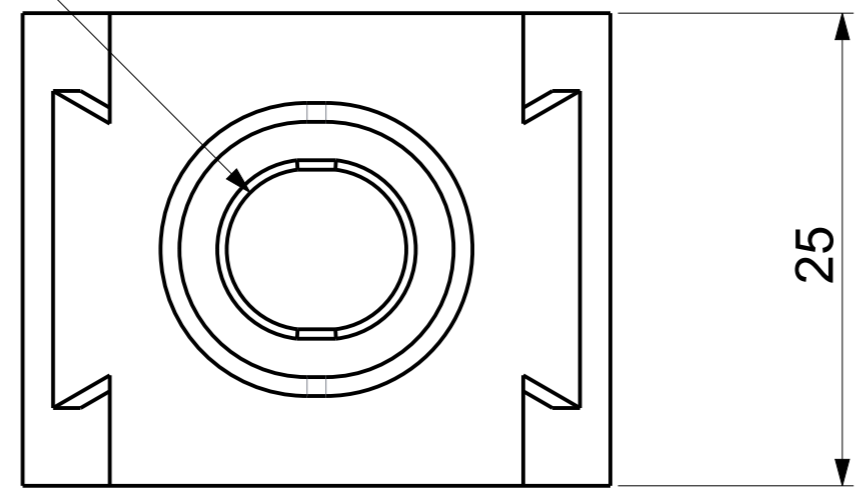

**STAINLESS STEEL
WEDGE CLAMP WITH STANDARD JAW**

Art.No. FG/WH/WEDCL/SSTJ1NP001

Model No. KD-STJ-SS-1

Tightening Torque. 20 Nm

Clamping Force. 15 kN