

DIN 912 M12

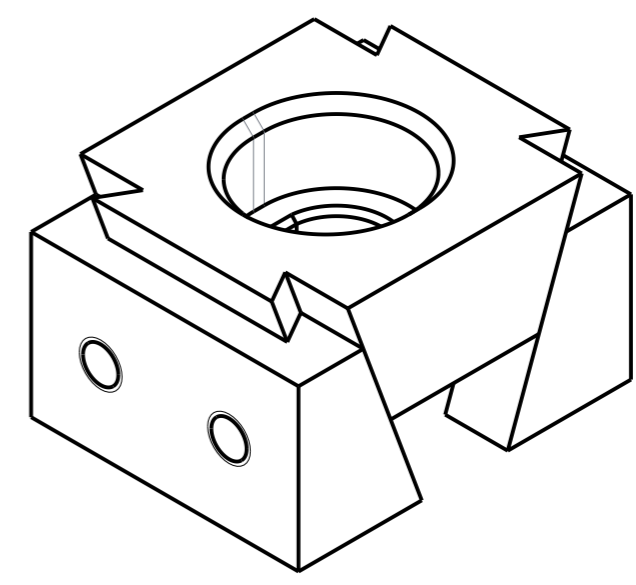
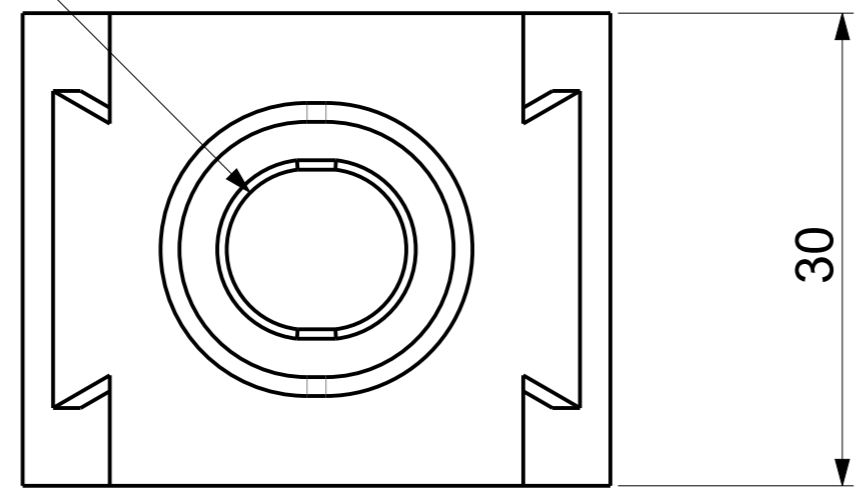

WEDGE CLAMP WITH STANDARD JAW

Art.No. FG/WH/WEDCL/0STJ2NP001

Model No. KD-STJ-2

Tightening Torque. 65 Nm

Clamping Force. 30 kN