

DIN 912 M8

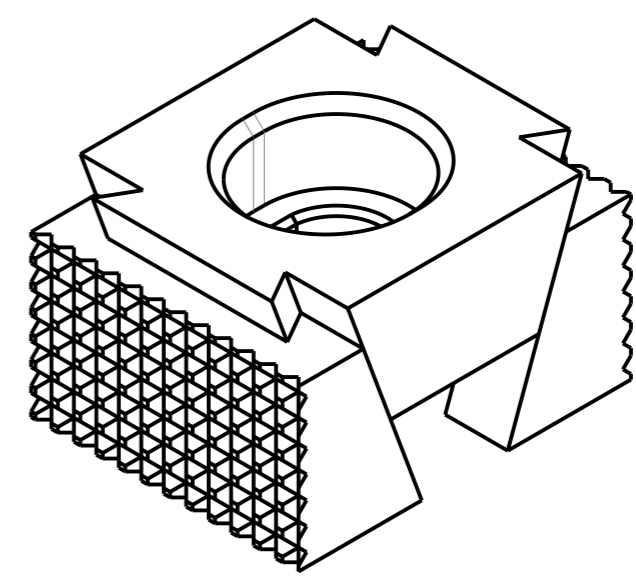
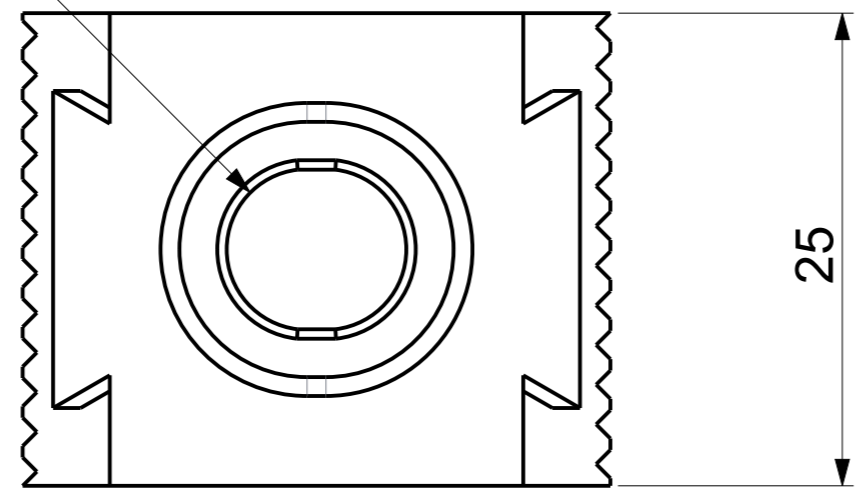

**STAINLESS STEEL
WEDGE CLAMP WITH SERRATED JAW**

Art.No.FG/WH/WEDCL/0SSJ1NP001
Model No. KD-SJ-SS-1
Tightening Torque. 20 Nm
Clamping Force. 15 kN